

**RTD sensor with standard head and with resistive element with interchangeable mountings**

**TBEI 50 – TBEID 50**

- Temperature sensor with or without compression fitting and stainless steel contact tip.
- Measuring range (According to reference) **from -80°C to +400°C** (PT100 and PT1000).  
**from -20°C to +120°C** (NTC).
- Mounting of wire : **single pair** (2,3 or 4 wires).  
**multipair** (4 or 6 wires).
- For other resistor type PT25, PT50, PT500, PT200 or NI, please contact us.

**Part numbers**

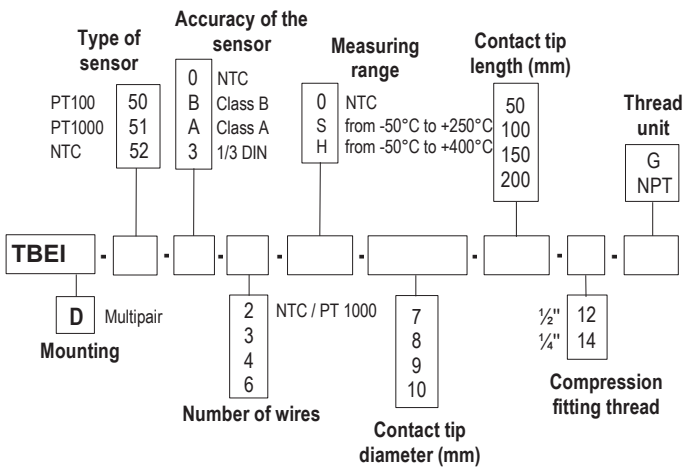

\* Other dimensions on request

**Example : TBEI-50-B-3-S-7-100-12G.**

**Model :** PT 100 temperature sensor class B, with 3 wires in a sheath of 7 mm diameter and 100 mm length (including thread), with a 1/2" G thread plug and with interchangeable element of 4 mm Ø and 140 mm length.

Standard measuring range from -50°C to 250°C.

**Dimensions**

- Schema of the sensor

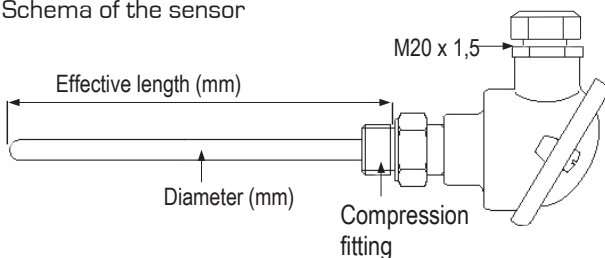

- Internal interchangeable element schema

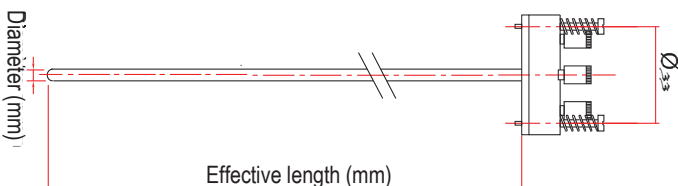

**Technical features**

- Working temperature**.....from -80°C to +400°C (PT100 and PT1000)  
*(According to reference)* from -20°C to +120°C (NTC)
- Accuracy**.....**PT100 or PT1000** : see "Tolerances" table  
**NTC** : see "Tolerances" table
- Type of sensor**.....**PT100 or PT1000** : Class B, Class A,  
1/3 DIN as per DIN IEC751  
**CTN** : resistance à 25°C, R<sub>25</sub> = 10KΩ  
Nominal Beta B25/85 value = 3,695K ±1%

**Mounting of wire**.....**single pair 2, 3 or 4 wires**  
For T>250°C do not use 4 wires in a sheath of 6mm Ø.

**multipair 4 or 6 wires**  
For T>250°C use sheath from 8 mm Ø.

- Storage temperature**.....from -20°C to +80°C
  - Contact tip**.....316 L stainless steel, no welding, 3/4 to 4/4 hard
  - Interchangeable element**.....316 L stainless steel  
**Diameter** : according to contact tip outer diameter
- | Interchangeable element Ø | Contact tip minimum Ø |
|---------------------------|-----------------------|
| 4 mm                      | 7 mm                  |
| 5 mm                      | 8 mm                  |
| 6 mm                      | 9 mm                  |
| 7 mm                      | 10 mm                 |
- LU length** : contact tip length + 40 mm
  - Compression fitting**.....316 L stainless steel
  - Thread**.....with or with out, 1/4, 1/2, male au pas Gas or NPT plug (other tread on request)
  - Electrical connection**.....with or without terminal block  
Transmitter 4/20mA 0/10V as option
  - Connection head**.....Aluminium alloy  
cable gland : M20 x 1,5  
IP65 protection
  - Adjustable mountings**.....compression fitting welded further along the sheath, flange, clamp, repleacable probe insert, restricted end, ambient end.  
See data sheet.



# Interchangeable element at resistive element

## EI 50 – EID 50

- Measuring range (according to reference) **from -80°C to +400°C** (PT100 and PT1000).  
**from -20°C to +120°C** (NTC).
- Mounting of wire : **simple** (2,3 or 4 wires).  
**duplex** (4 or 6 wires).
- For other resistor type PT25, PT50, PT500, PT200 or NI, please contact us.

### Part numbers

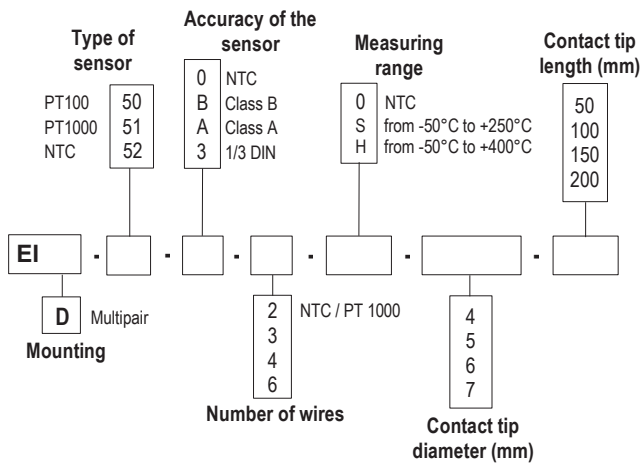

\* Other dimension on request

**Length LU** : contact tip length + 40 mm

**Example** : EI-50-B-3-S-7-100.

**Model** : Interchangeable element PT 100 class B, 3 wires diameter 7mm and thread length included of 100 mm.

Standard measuring range from -50°C to 250°C.

### Dimensions

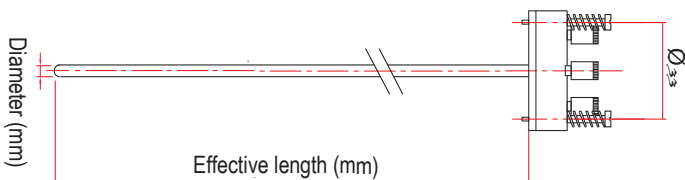

### Technical features

**Working temperature**.....from -80°C to +400°C (PT100 and PT1000)  
(According to reference) from -20°C to +120°C (NTC)

**Exactitudes**.....**PT100 or PT1000** : see "Tolerances" table  
NTC : see "Tolerances" table

**Type of sensor**.....**PT100 or PT1000** : Class B, Class A,  
1/3 DIN as per DIN IEC751  
NTC : resistance at 25°C,  $R_{25} = 10K\Omega$   
Nominal Beta B25/85 value = 3,695K ±1%

**Mounting of wire**.....**single pair 2, 3 or 4 wires**  
For  $T > 250^\circ C$  do not use 4 wires in a sheath of 6mm Ø.  
**multipair 4 or 6 wires**  
For  $T > 250^\circ C$  use sheath from 8 mm Ø.



**Storage temperature**.....from -20°C to +80°C

**Contact tip**.....316 L stainless steel, no welding, 3/4 to 4/4 hard

**Interchangeable element**.....316 L stainless steel  
**Diameter** : according to contact tip outer diameter

Interchangeable element Ø	Contact tip minimum Ø
4 mm	7 mm
5 mm	8 mm
6 mm	9 mm
7 mm	10 mm

**LU Length** : contact tip length + 40 mm

**Electrical connection**.....with or without terminal block  
Transmitter 4/20mA 0/10V as option  
with or without terminal block put on DIN 42 mm Ø kit  
Pitch 33 mm.

## Useful information on thermometry with platinum resistor PT100, PT1000 or NTC .

### • 2-wire connection

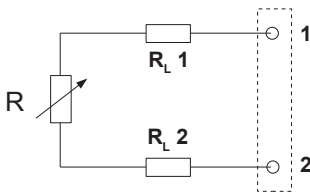

This is the simplest way, but line resistors (RL1 and RL2) are connected to the sensor in a series circuit. The addition of RL1 + RL2, leads to an off-set between measured temperature and real temperature. This connection must be avoided.

### • 3-wire connection

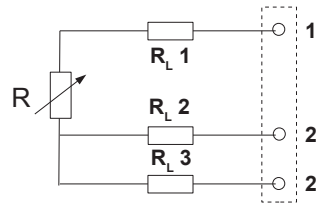

This connection involves identical line resistors (RL1-RL2-RL3), RL2 + RL3 allow you to measure the line resistance that will be subtracted from the measured resistance between 1 and 22' terminals. This is the most common connection.

### • 4-wire connection

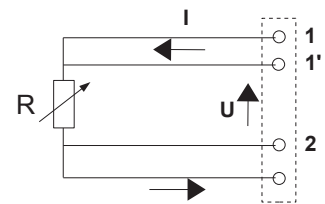

Regulated current is going through 11' and 22' terminals and the measurement is made at the sensor terminals, so none of the line resistors are taken into account. This is the most accurate connection.

## Tolerance\* of PT100 and PT1000 probes.

Norms as per IEC 751 (1993), BS 1904 (1984) et DIN 43760 (1980).

Temp °C	Tolerances					
	Class B		Class A		1/3 DIN	
	± °C	± Ohms	± °C	± Ohms	± °C	± Ohms
-100	0,8	0,32	0,35	0,14	0,27	0,11
-50	0,55	0,22	0,25	0,1	0,19	0,08
0	0,3	0,12	0,15	0,06	0,1	0,04
100	0,8	0,3	0,35	0,13	0,27	0,1
200	1,3	0,48	0,55	0,2	0,44	0,16
300	1,8	0,64	0,75	0,27	0,6	0,21
400	2,3	0,79	0,95	0,33	0,77	0,26

\*Resistance values for PT1000 (Ω) must be multiplied by 10 for the same corresponding temperature value (°C). I.e : at 0°C for Class B PT1000 ± 0.3°C → ± 1.2 Ω

## Accessories (See data sheet)

- Transmitter output 4/20 mA or 0/10V
- Wall fixing support
- Stainless steel mounting brackets
- ¼ " or ½ " Gas screw nut
- Stainless steel compression fitting
- Teflon or stainless steel ferrule for compression fittings
- Sleeve to weld for food industry
- Stainless steel union fitting
- ½ " Gas or NPT thread cuff
- Thermo-conducting silicone grease
- Calibration certificate
- Thermowell



**www.kimo.fr**

**EXPORT DEPARTMENT**

Tel : + 33. 1. 60. 06. 69. 25 - Fax : + 33. 1. 60. 06. 69. 29

e-mail : [export@kimo.fr](mailto:export@kimo.fr)



Distributed by :

**PRC Technologies Corp., Ltd.**

Tel: 02 530 1714, 02 530 1619, 02 530 1621

Fax: 02 530 1731

Email: [info@prctechth.com](mailto:info@prctechth.com), [www.prctechth.com](http://www.prctechth.com)